

Norse



terratinta 100%
ceramiche made in Italy



Index

Norse	p. 04
Collection	p. 06
Decorative Program	p. 36
Norse Outdoor	p. 44
Packaging	p. 50
Technical features	p. 52

Norse

^{EN}It is the story of a material which, thanks to its qualities of neutrality and versatility of use, becomes the protagonist of ceramic projects capable of experimenting with new design and aesthetic standards. Norse comes in various sizes developed in a palette of 7 neutral shades, both warm and cold, characterized by a surface that presents the effect of manual drafting with a slight graphic movement and is completed with new decorative patterns perfectly matched to create refined and unusual total looks and guarantee a high level of customization in line with current trends for increasingly original and individual settings, casual and comfortable but at the same time with elegant sobriety and which promote the idea of "intimacy" as a lifestyle, a perfect marriage of neat minimalism that is also warm and inviting.

^{IT}E' il racconto di un materiale che, grazie alle sue qualità di neutralità e versatilità di impiego diviene protagonista di progetti ceramici capaci di sperimentare nuovi canoni progettuali ed estetici. Norse si sviluppa in diversi formati declinati in una palette di 7 tonalità neutre, sia calde che fredde, caratterizzate da una superficie che presenta un effetto di stesura manuale con un leggero movimento grafico e si completa con patterns decorativi inediti perfettamente abbinati per creare total look ricercati e inusuali e garantire un elevato livello di personalizzazione in linea con le tendenze attuali per ambienti sempre più originali e individuali, casual e confortevoli ma al tempo stesso dalla sobrietà elegante e che promuovano l'idea di "intimità" come stile di vita, un perfetto connubio tra un minimalismo ordinato che è anche caldo e invitante.



Norse

Material: Porcelain stoneware | Gres porcellanato

Surface: matt RIO and ultra matt R11 rectified | matt RIO e ultra matt R11 rettificato

Thickness: matt 10mm | ultra matt 20mm **TH/CK**_{20mm}

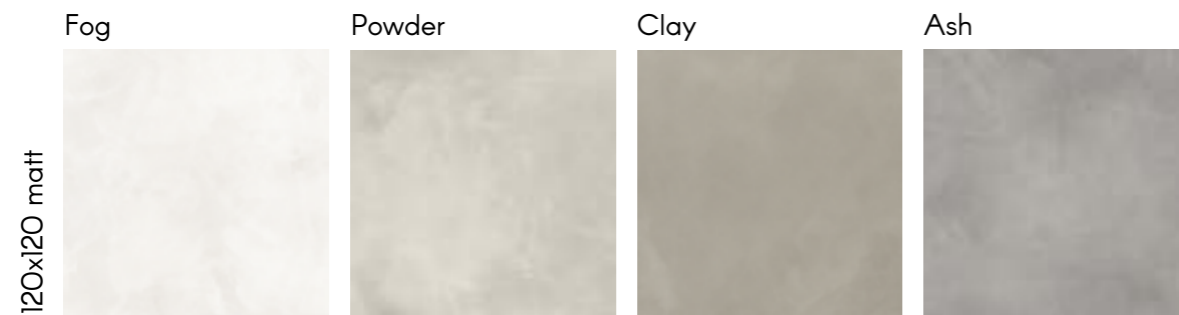
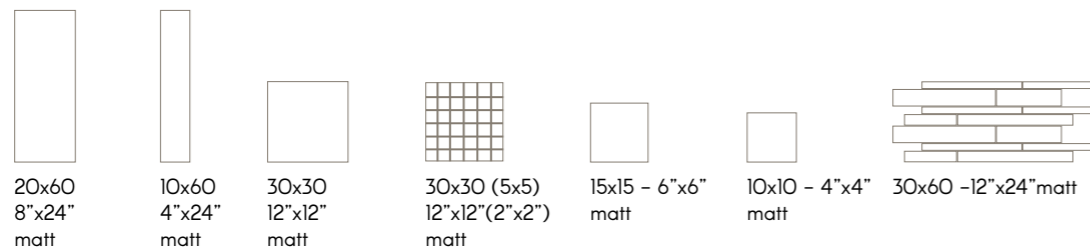
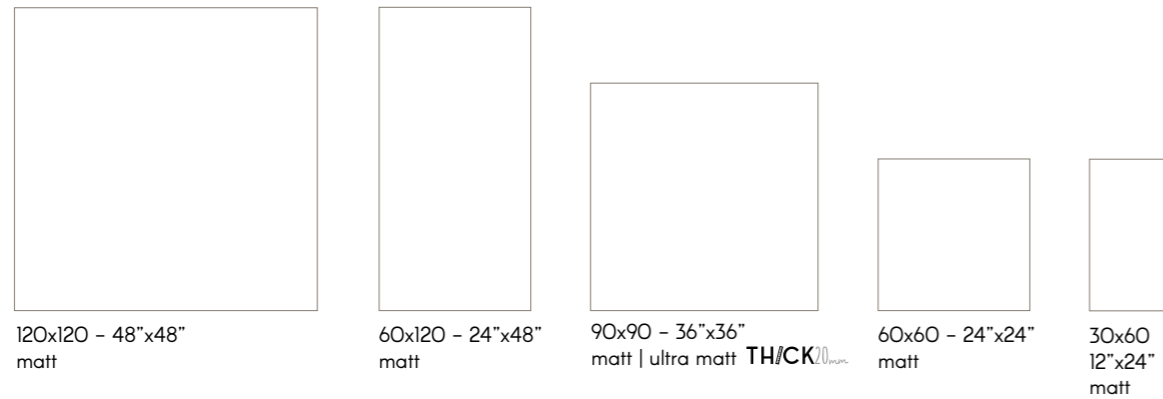

Fog

Powder

Clay

Ash

Mud

Crete

Earth

Fog



Fog 60x120 - 24"x48"



Wall: Fog 60x120 - 24"x48"
Floor: Fog 60x60 - 24"x24"

Fog



Powder



Powder 90x90 - 36"x36"

Floor: Powder 90x90 - 36"x36"



Powder

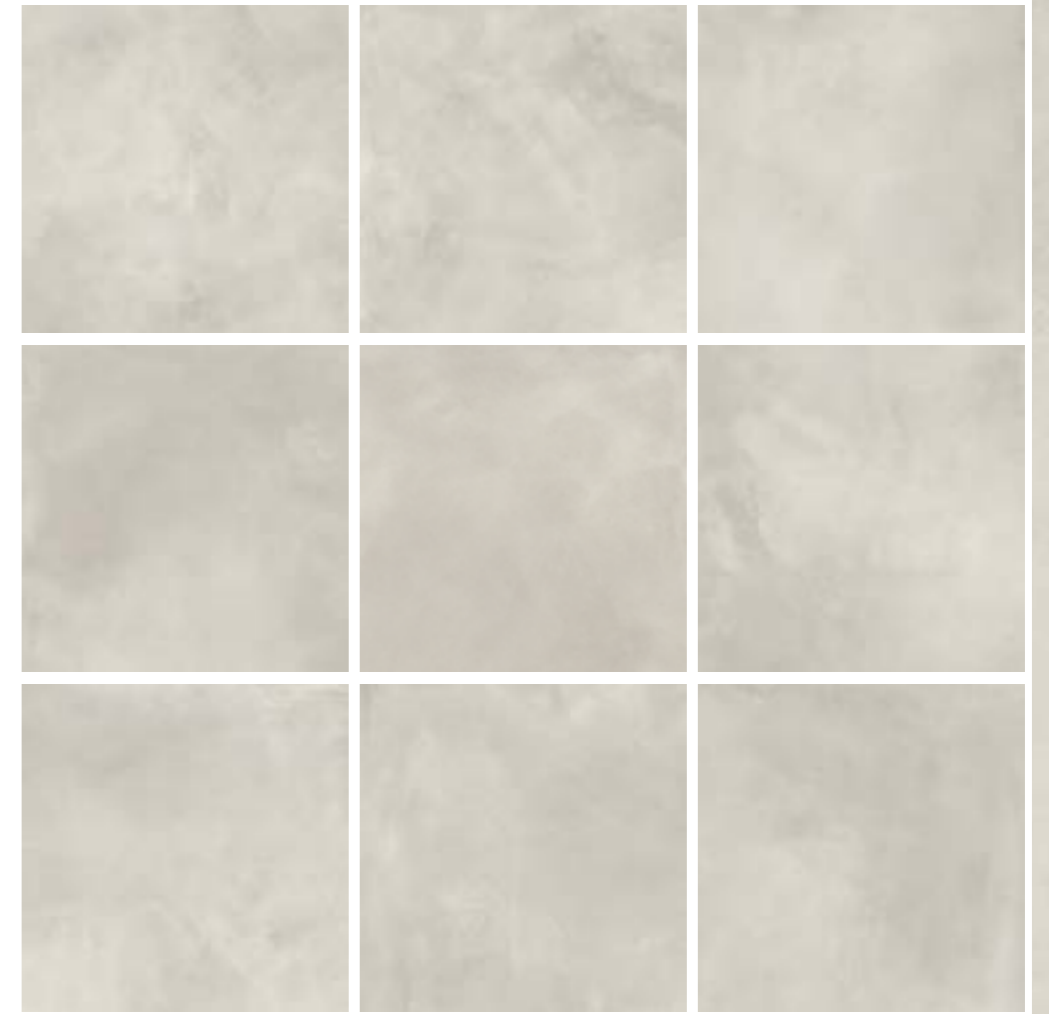

Clay



Wall: Clay 60x120 - 24"x48"
Roller Clay 10x30 - 4"x12"
Floor: Clay 60x60 - 24"x24"



Clay



Wall: Clay 60x120 - 24"x48" matt
Roller Clay 10x30 - 4"x12" matt
Floor: Clay 60x60 - 24"x24" matt

Ash

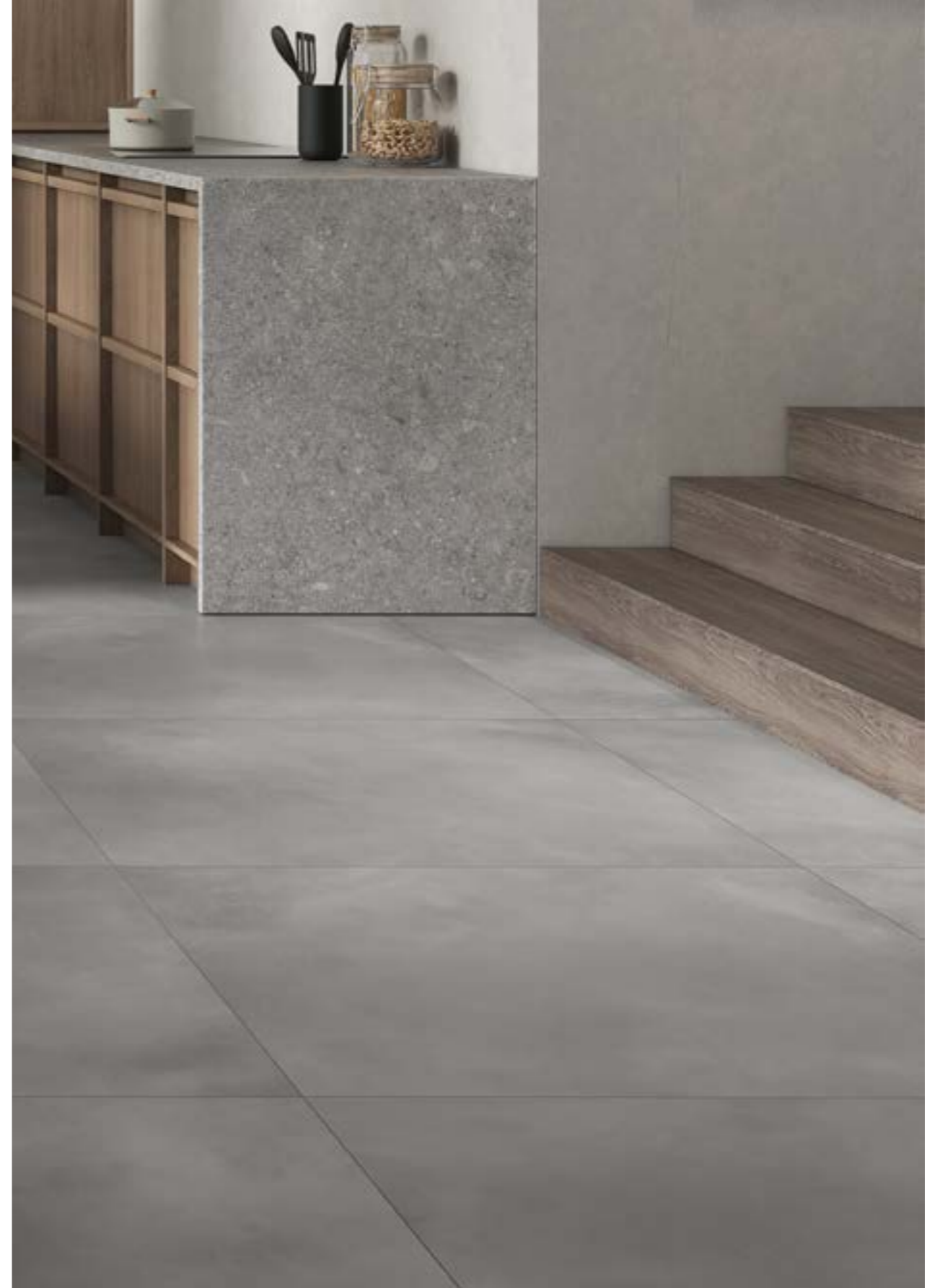

Counter and top: Vicentina Genere
160x320 - 63"x126" matt
Floor: Ash 90x90 - 36"x36" matt



Ash



Counter and top: Vicentina Cenere
160x320 - 63"x126" matt
Floor: Ash 90x90 - 36"x36" matt

Mud

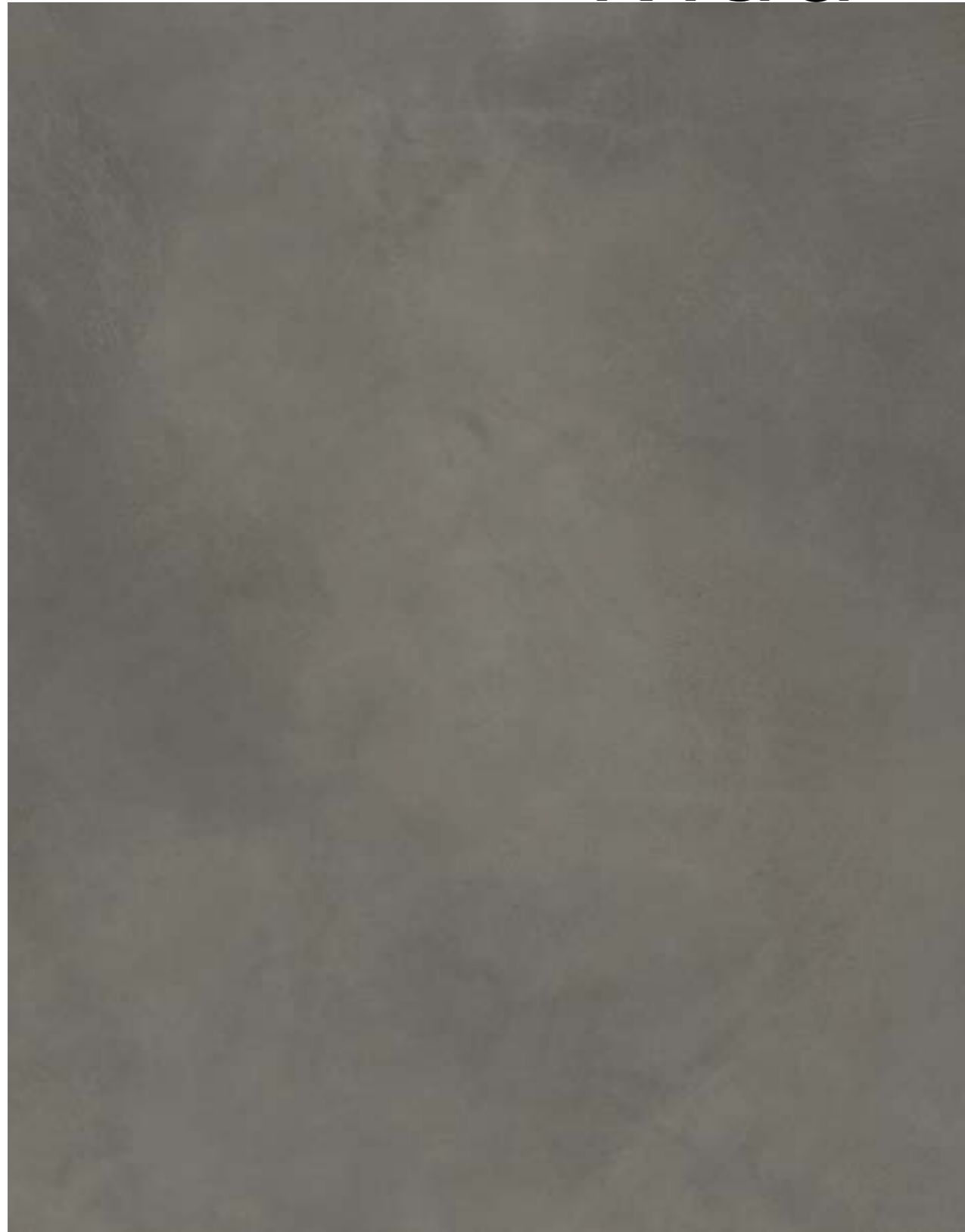

Mud 90x90 - 36"x36" matt



Mud

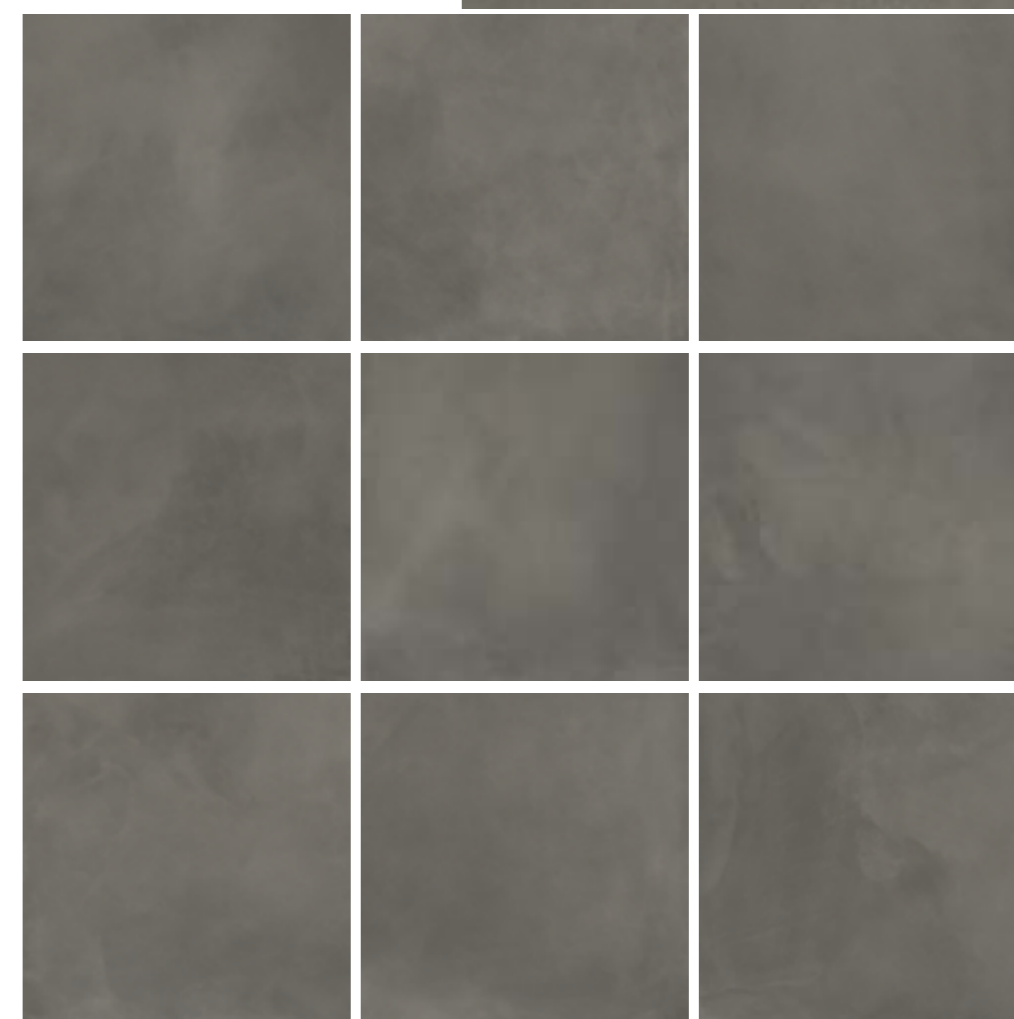

Mud 90x90 - 36"x36" matt

Crete



Crete 60x120 - 24"x48" matt



Crete 60x120 - 24"x48" matt

Crete



Earth



Wall: Earth 60x120 - 24"x48" matt
Floor: Clay 90x90 - 36"x36" matt



Wall: Earth 60x120 - 24"x48" matt
Floor: Clay 90x90 - 36"x36" matt

Earth



Decors / Decori hand made

Roller



Roller
End



Hyper

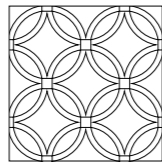

Knit

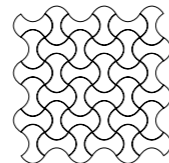

^{EN}Norse's decorative program includes a series of elements that combine materials, colours and three-dimensional modular features to provide a sensorial interpretation that amplifies the perception of the wall covering and allows multiple compositions. Designers break away from the conventions of tiles' use, creating evocative and unpredictable spaces by alternating tone-on-tone colours to match the tones of the collection to saturated shades taken from the Hexa palette.

^{IT}Il programma decorativo di Norse prevede una serie di complementi che combinando materie, cromatismi e elementi modulari tridimensionali offrono un'interpretazione sensoriale che amplifica la percezione del rivestimento a parete e permette molteplici composizioni. I designer si sottraggono alle solite convenzioni d'uso delle piastrelle, creando spazi suggestivi e imprevedibili, alternando colori tono su tono in pendant con le tonalità della collezione a sfumature sature tratte dalla palette Hexa.



hand
made

Hyper

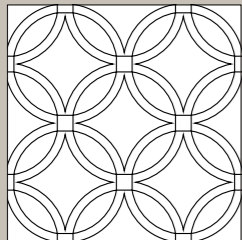

30x30 - 12"x12"
glossy

Thickness | Spessore
10mm



White

Wall: Hyper White
30x30 - 12"x12" glossy
Floor: Clay 90x90 - 36"x36" matt



hand
made

Roller

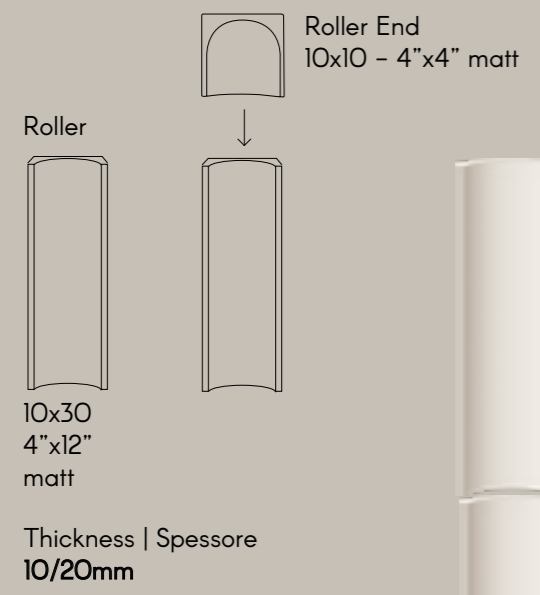

Fog

Colors
Available in all the colors of the series
Disponibile in tutti i colori della serie



Clay 60x120 - 24"x48" matt
Roller Clay 10x30 - 4"x12" matt

hand
made
Knit



mosaic 30x30
12"x12" matt

Thickness | Spessore
10mm



Lemon Sorbet

Colors

Available colors | Colori disponibili



Lemon Sorbet



Wild Sage



Azure Mist



Laurel Green



Rusty Red



Black Swan



Wall: Knit mosaic Lemon Sorbet
30x30 - 12"x12" matt
Top: Vicentina Genere
160x320 - 63"x126" matt

Norse Outdoor

THICK_{20mm}

Material: Porcelain stoneware | Gres porcellanato

Surface: ultra matt R11 rectified | ultra matt R11 rettificato

Thickness: 20mm THICK_{20mm}

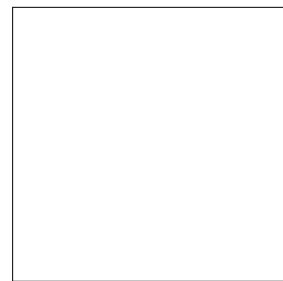

90x90 - 36"x36"
ultra matt

Powder



Clay



Ash



THICK_{20mm}
COLORS ultra matt



Powder 90x90 - 36"x36"























Ash 90x90 - 36"x36"



Clay 90x90 - 36"x36"

Packaging Imballi

	BOX			PALLET		
	PZ PCS	SQ.MT.	KG	BOXES	SQ.MT.	KG
 120x120 - 48"x48" matt Fog Powder Clay Ash	2	2,88	59,04	16	46,08	970
 60x120 - 24"x48" matt	2	1,44	30,00	32	46,08	980
 90x90 - 36"x36" matt	2	1,62	35,00	20	32,40	720
 90x90 - 36"x36" ultra matt TH/CK 10mm. Powder Ash Clay	1	0,81	34,57	21	17,01	746
 60x60 - 24"x24" matt	3	1,08	23,75	40	43,20	970
 30x60 - 12"x24" matt	6	1,08	23,55	40	43,20	962
 30x30 - 12"x12" matt	11	1,00	21,80	48	48,00	1066
 20x60 - 8"x24" matt	8	0,96	20,95	48	46,08	1026
 10x60 - 4"x24" matt	15	0,90	19,65	40	36,00	806
 10x10 - 4"x4" matt	50	0,50	10,90	50	25,00	565
 15x15 - 6"x6" matt	44	1,00	21,80	48	48,00	1066
 mosaic 30x30 (5x5) 12"x12" (2"x2") matt	11	1,00	21,50	30	30,00	665
 mosaic 30x60 12"x24" matt	6	1,08	23,25	30	32,40	718
 Hyper 30x30 - 12"x12" glossy	5	0,50	10,90	50	25,00	565
 Roller 10x30 4"x12" matt	16	0,48	10,00	42	20,16	440
 Roller End 10x10 4"x4" matt	13	0,13	2,68	115	14,95	330
 Knit 30x30 12"x12" matt	7	0,63	9,00	42	26,46	398
 skirting 5x60 - 2"x24" matt	12	7,20ml	8,00	-	-	-
 skirting 5x90 - 2"x36" matt	12	10,80ml	12,00	-	-	-
 step 30x60 - 12"x24" matt	6	-	26	-	-	-
 step tread 34x90 14"x36" matt	2	-	17,50	-	-	-

The information contained in this catalogue is correct to the best of our knowledge and update at the catalogue printing time; therefore the listed data is subject to change. The colours and shades shown here are only indicative.

Le informazioni contenute nel presente catalogo sono il più possibile esatte ed aggiornate al momento della stampa, pertanto i dati elencati possono subire variazioni. I colori e le tonalità qui riprodotti sono indicativi.





Technical Features

Caratteristiche tecniche

valid for **ROLLER NORSE matt**

TECHNICAL FEATURES EXTRUDED WHITE-BODY TILES
CONFORMING TO EN 14411 ISO 13006 STANDARDS ANNEX F GROUP AIII GL EB > 10%

CARATTERISTICHE TECNICHE PIASTRELLE ESTRUSE IN PASTA BIANCA Conformi a norme EN 14411 ISO 13006 Appendice F Gruppo AIII GL EB > 10%
TECHNISCHE EIGENSCHAFTEN STRANGEZOGENEN FLIESEN Gemäß den Normen EN 14411 ISO 13006 Appendix F Gruppe AIII GL EB > 10%
CARACTERISTIQUES TECHNIQUES POUR PATE BLANCHE EXTRUDÉES Conformes aux Normes Européennes EN 14411 ISO 13006 App. F Groupe AIII GL EB > 10%















TECHNICAL FEATURES CARATTERISTICHE TECNICHE TECHNISCHE DATEN CARACTERISTIQUE TECHNIQUE	TESTING METHOD METODICA DI PROVA PRÜFVERFAHREN NORME D'ESSAIS	TEST RESULTS VALORE PRODOTTO PRODUKT WERTE VALEUR PRODUIT
 Water absorption Assorbimento acqua Wasseraufnahme Absorption d'eau	EN ISO 10545-3	E _b > 10%
 Breaking strength Carico di rottura Bruchlast Charge de rupture	EN ISO 10545-4	NPD
 Glaze crazing resistance Determinazione della resistenza al cavillo Glasurearrißbeständigkeit Résistance aux taches	EN ISO 10545-11	Resistant Resistente Widerstandsfähig Résistant
 Chemical resistance Resistenza ai prodotti chimici Chemikalienbeständigkeit Résistance aux produits chimiques	EN ISO 10545-13 EN ISO 10545-14	Min. class B Min. class 3

valid for **NORSE matt | ultra matt**

TECHNICAL FEATURES UNGLAZED PORCELAIN STONEWARE
CONFORMING TO EUROPEAN STANDARDS EN 14411 ISO 13006 APP. G (GROUP BIA UGL WITH E_b ≤ 0,5%)

CARATTERISTICHE TECNICHE GRÈS PORCELLANATO NON SMALTATO Conformi a Norme Europee EN 14411 ISO 13006 App. G (Gruppo Bia UGL con E_b ≤ 0,5%)
TECHNISCHE EIGENSCHAFTEN UNGLASIERTES FEINSTEINZEUG Gemäß den Europäischen Normen EN 14411 ISO 13006 App. G (Gruppe Bia UGL mit E_b ≤ 0,5%)
CARACTERISTIQUES TECHNIQUES GRES CERAME NON ÉMAILLÉ Conformes aux Normes Européennes EN 14411 ISO 13006 App. G (Groupe Bia UGL avec E_b ≤ 0,5%)



TECHNICAL FEATURES CARATTERISTICHE TECNICHE TECHNISCHE DATEN CARACTERISTIQUE TECHNIQUE	TESTING METHOD METODICA DI PROVA PRÜFVERFAHREN NORME D'ESSAIS	REFERENCE STANDARD RIFERIMENTO NORMA STANDARDWERT RÉFÉRENCE NORME	TEST RESULTS VALORE PRODOTTO PRODUKT WERTE VALEUR PRODUIT
 Sizes Dimensioni Abmessungen Dimensions	EN ISO 10545-2	N ≥ 15 cm • Length and width - Lunghezza e larghezza • Thickness - Spessore - Stärke - Epaisseur • Linearity - Rettilineità spigoli - Kantengeradheit- Rectitude des arêtes • Wedging - Ortogonalità - Rechtwinkligkeit Orthogonalité • Warpage - Planarity - Ebenföchigkeit-Planité • Appearance: % of acceptable tiles, per lot Aspetto: % di piastrelle accettabili nel lotto Aussehen: % der akzeptablen Fliesen pro Los Aspect: % de carreaux acceptables sur la fourniture totale	(%) (mm) ±0,6% ±2,0 mm ±5,0% ±0,5 mm ±0,5% ±1,5 mm ±0,5% ±2,0 mm ±0,5% ±2,0 mm 95% min.
 Water absorption Assorbimento acqua Wasseraufnahme Absorption d'eau	EN ISO 10545-3	E _b ≤ 0,5%	Compliant Conforme Erfüllt Conforme
 Modulus of rupture Resistenza alla flessione Biegezugfestigkeit Résistance à la flexion	EN ISO 10545-4	Medium value 35 N/mm ² min.	Compliant Conforme Erfüllt Conforme
 Breaking strength Carico di rottura Bruchlast Charge de rupture	EN ISO 10545-4	sp. > = 7,5 mm: min 1300 N	Compliant Conforme Erfüllt Conforme
 Abrasion resistance Resistenza all'abrasione Abriebbeständigkeit Résistance à l'abrasion	EN ISO 10545-6	175 mm ³ max	Average Medio - Mittelwert Moyenne < 150 mm ³
 Thermal expansion coefficient Coefficiente di dilatazione termica lineare Wärmeausdehnungskoeffizient Coefficient de dilatation thermique linéaire	EN ISO 10545-8	*Declared value Valore dichiarato Angegebener Wert Valeur déclaré	≤9 MK-1
 Thermal shock resistance Resistenza agli sbalzi termici Temperaturwechselbeständigkeit Résistance aux écarts de température	EN ISO 10545-9	*Pass according to ISO 10545-1 Test superato in accordo con ISO 10545-1 Test überstanden nach ISO 10545-1 Pv en accord avec norme en 10545-1	Resistant Resistente Widerstandsfähig Résistant
 Frost resistance Resistenza al gelo Frostbeständigkeit Résistance au gel	EN ISO 10545-12	*Pass according to ISO 10545-1 Test superato in accordo con ISO 10545-1 Test überstanden nach ISO 10545-1 Pv en accord avec norme en 10545-1	Resistant Resistente Widerstandsfähig Résistant
 Resistance to low concentrations of acids and alkali Resistenza a basse concentrazioni di acidi e alcali Beständigkeit gegen schwach konzentrierten Säuren und Laugen Résistance à des basses concentrations d'acides et bases	EN ISO 10545-13	*Declared value Valore dichiarato Angegebener Wert Valeur déclaré	From ULA to ULB Da ULA a ULB Von ULA bis ULB De ULA jusqu'à ULB
 Resistance to high concentrations of acids and alkali Resistenza ad alte concentrazioni di acidi e alcali Beständigkeit gegen stark konzentrierten Säuren und Laugen Résistance à des hautes concentrations d'acides et bases	EN ISO 10545-13	*Declared value Valore dichiarato Angegebener Wert Valeur déclaré	From UHA to UHB Da UHA a UHB Von UHA bis UHB De UHA jusqu'à UHB
 Resistance to domestic chemicals and additives for swimming pools Resistenza ai prodotti chimici di uso domestico e agli additivi per piscina Beständigkeit gegen chemischen Haushaltsreiniger und Zusatzstoffe für Schwimmbäder Résistance aux prod. chimiques d'usage domestique et additifs pour piscines	EN ISO 10545-13	UB min.	UA
 Stain resistance Resistenza alle macchie Fleckenbeständigkeit Résistance aux taches	EN ISO 10545-14	*Declared value Valore dichiarato Angegebener Wert Valeur déclaré	CLASS 5
 Colors resistance to light Resistenza dei colori alla luce Lichtbeständigkeit Résistance des couleurs a la lumière	DIN 51094	No noticeable color change. Non devono presentare apprezzabili variazioni di colore. Die Muster dürfen keine sichtbaren Farbveränderungen aufweisen. Ne doivent pas présenter de variations importantes des couleurs.	No alteration after testing Materiale inalterato dopo il test Keine Veränderung nach dem Test Aucune altération relevée
 Friction coefficient (Slipperiness) Coefficiente di attrito (Scivolosità) Reibungskoeffizient (Schlupfrigkeit) Coefficient de friction (Glissement)	DIN 51130 ANSI A137.1 (DCOF)	*Declared value Valore dichiarato Angegebener Wert Valeur déclaré	R10 matt R11 ultra matt >0,42

TERRATINTA
group



"Stay hungry, stay foolish."

S. Jobs 1955-2011



CHANGE
TOGETHER

#notaclassicstory

brand of Terratinta Group Srl SB

// 45, via Viazza II Tronco
41042 Fiorano Modenese (MO) Italy

T +39 0536911408

F +39 05361940223

 Terratinta Group

 terratintagroup

#terratintastyle

Printed in March 2024

CHANGE



DOWNLOAD
AREA

terratinta
ceramiche 
terratintagroup.com